

ROBAM

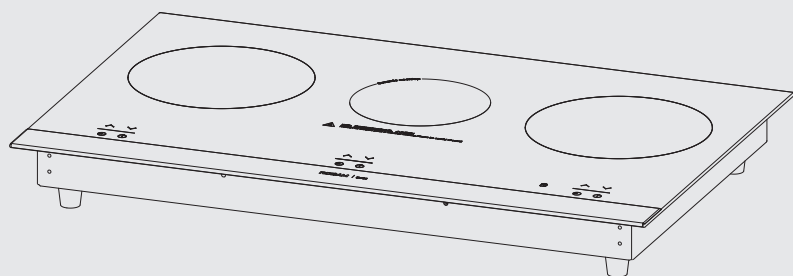

Operation Manual

CD32-W985

CD28-W985

Multifunction Hob

Contents

1.Product Overview -----	1
2.Product Structure -----	1
3.Product Parameters -----	2
4.Product Feature -----	2
5.Notice -----	3
6. Use Instruction-----	5
7. Electrical Schematic Diagram -----	7
8. General Troubleshooting -----	8
9. Installation Instruction -----	9
10. Cleaning and Maintenance -----	10
11.Accessories -----	10

Product Overview

Dear users:

Let us take this opportunity to thanks for your buying of ROBAM multifunction hob. We recommend that before the installation and using, please read this manual and save it for your future reference.

ROBAM is a professional enterprise in China's household appliances and kitchenware. It's famous with advanced design,high efficiency, saving energy and safety.

Product Structure

General structure diagram

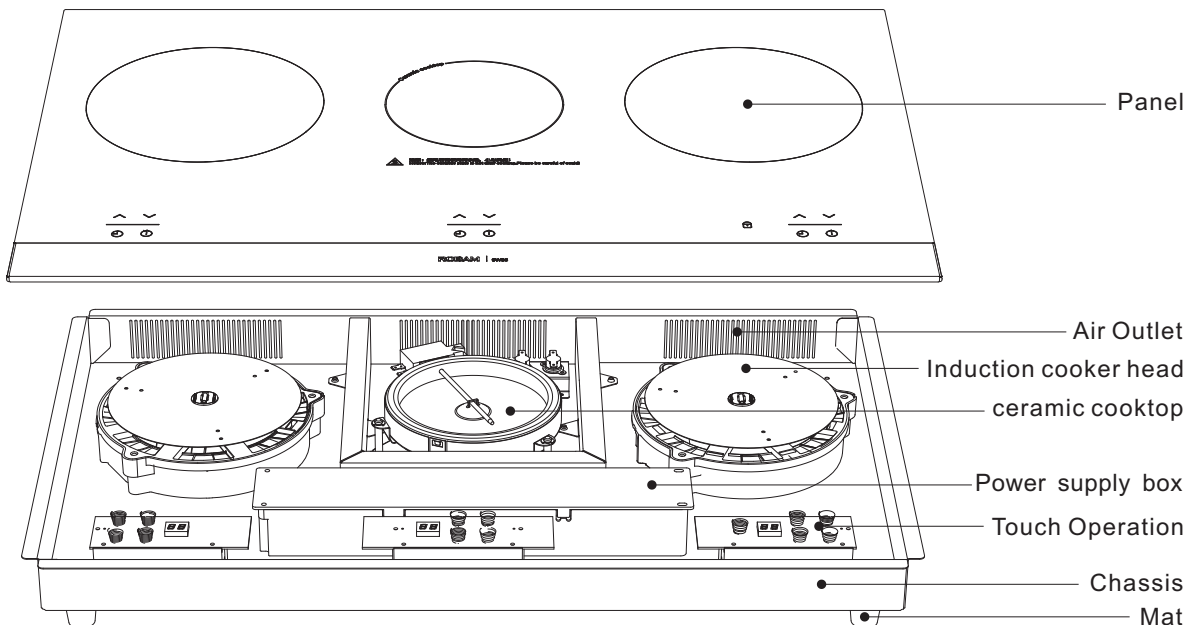

(The picture is just for your reference)

Product Parameters

Name	Multifunction Hob	
Item No.	CD32-W985	CD28-W985
Power Supply	See the label	
Left burner maximum power	See the label	
Middle burner maximum power	See the label	
Right burner maximum power	See the label	
Rated Power	See the label	
Dimension(mm)	800×500×55	
Net Weight(kg)	12	
Burners	3	
Panel	Temple glasses(microcrystal panel)	
Installation size(mm)	758×458	

Marks: ROBAM reserves rights to change the design and specification.

Product Feature



ROBAM series of multifunction hob is developed on the base of overseas advanced technology which is available of modern family. Our multifunction hob has fashionable style and safe characteristic.

- 1.Safe — have multiple protecting functions and safe to operate;
- 2.Friendly-environment— without flame, smoke and baleful oil, for example, CO;
- 3.Sanitation — ceramic glass panel with high rigidity, easy to clean;
- 4.Convenience — use pattern control panel, simple to understand;
- 5.High efficient — high heat efficient, save energy;
- 6.Credibility — credible feature and long life;

Notice

NOTICE :

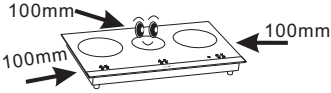
! When you operate our multifunction hob, please pay much attention to following notice articles:

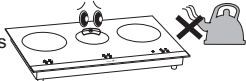
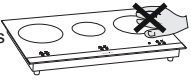
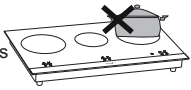
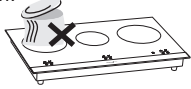
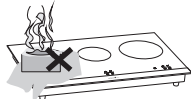
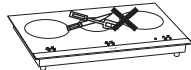
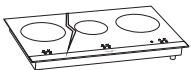
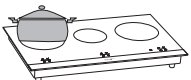
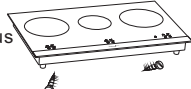
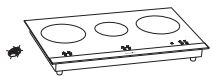
<p>The product should be put horizontally. Don't allow to put it near wall or object. The distance of each side should be more than 100mm. The inlet and outlet must keep expedite.</p>  <p style="text-align: right;">1</p>	<p>For UK plug, please use specific more than 13A electric outlet independently. For French plug, please use specific more than 16A electric outlet independently. Don't use universal socket with other appliances and ensure plug earthed properly.</p> <p style="text-align: right;">2</p>	<p>Don't use this product near water or bath it by water directly. It may cause troubles on inlet row or outlet row.</p>  <p style="text-align: right;">3</p>
<p>Please far away from gas hob or other heated utensil during working. If the temperature on environment becomes too high, it may cause the overheated protection of induction cooker, so it will stop heating.</p> <p>dangerous</p>  <p style="text-align: right;">4</p>	<p>Don't touch induction cooker by hands immediately after operation. Because the surface of panel shall be hot and may cause scald.</p> <p>dangerous</p>  <p style="text-align: right;">5</p>	<p>Don't allow to heat pan without anything food, it may destroy this product or pan.</p> <p>dangerous</p>  <p style="text-align: right;">6</p>
<p>For sealed packages of food, for example, can, please open the cover before heating preventing from explosive danger because of expansion.</p>  <p style="text-align: right;">7</p>	<p>Don't put paper, cloth, aluminum foil or other flammable material between the panel and utensil or the bottom of induction cooker to heat. It may cause the danger of fire.</p>  <p style="text-align: right;">8</p>	<p>Don't allow to put metal object on the panel directly, for example, knife, folk, scoop, etc. It may cause scald.</p>  <p style="text-align: right;">9</p>
<p>If the panel is broken, users must cut off the power immediately preventing from electric shock. And users should send this product to our after-service center.</p>  <p style="text-align: right;">10</p>	<p>Please heat utensil in the middle of heating area. It may cause melting when the temperature of utensil transmit to the plastic part.</p>  <p style="text-align: right;">11</p>	<p>Prohibited insert wire or screw into inlet or outlet. It may cause dangerous of electric shock.</p> <p>dangerous</p>  <p style="text-align: right;">12</p>
<p>Prevent cockroach or other insect entering into the machine from inlet row or outlet row. It may cause default.</p>  <p style="text-align: right;">13</p>	<p>Don't allow children to touch this product easily. Prohibited children or blindman to operate it independently.</p> <p style="text-align: right;">14</p>	<p>During working process, if there is water on the button area, please use dry cloth to clean it in time because it may cause operation failure.</p> <p style="text-align: right;">15</p>

Statement: The adverse consequences caused by the violation of the above matters needing attention in using risk, damage, etc. Our company is not responsible for.

※Notice:

1.The multifunction hob under working process, panel surface temperature will become very hot, don't touch it in order to avoid scald.

2. Please don't put the product where children can easily touch. Don't allow children and the blindman to operate product independent in order to avoid has the danger.

3.During working process, if there is some water on control panel, please use dry cloth to clean it in time, or it may cause operation failure.

4. Please don't touch the surface of ceramic hob in one hour after finished cooking food.

Statement: The adverse consequences caused by the violation of the above matters needing attention in using risk, damage, etc. Our company is not responsible for.

5.This appliance is not intended for use by persons (including children) with reduced physical,sensory or mental capabilities, or lack of experience and knowledge, unless they have been given supervision or instruction concerning use of the appliance by a person responsible for their safety.

6.Children should be supervised to ensure that they do not play with the appliance.

7.If the supply cord is damaged, it must be replaced by the manufacturer, its service agent or similarly qualified persons in order to avoid a hazard.

8.**WARNING:** If the surface is cracked, switch off the appliance to avoid possibility of electric shock.

9.The appliance is not intended to be operated by means of an external timer or separate remote-control system.

10.**Danger of fire:** Do not store items on the cooking surface.

11.**CAUTION:** the cooking process has to be supervised. A short term cooking process has to be supervised continuously.

12.**WARNING:** Unattended cooking on a hob with a fat or oil can be dangerous and may result in a fire.

◆Suitable utensil and container

Iron material (enamel, cast iron, stainless steel) or other multiple magnetic induction utensil. The diameter of flat bottom should be more than 100mm but less than 260mm.

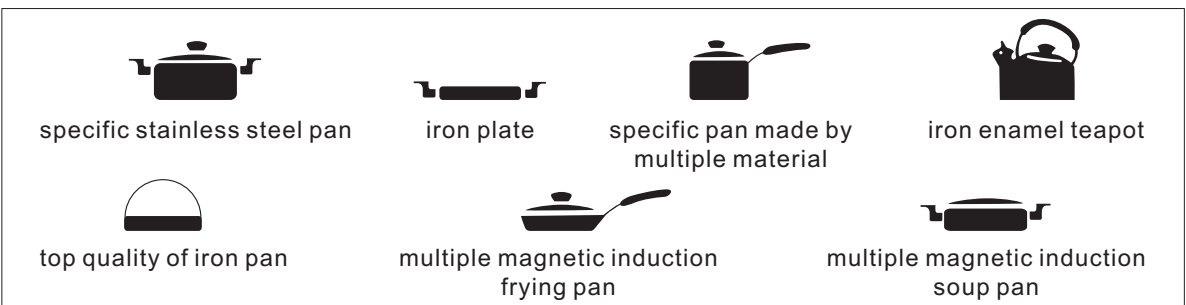

◆Unsuitable Utensil or container for induction cooker part

Pan made by ceramic, glass, aluminum or copper. The diameter of pan's bottom is less than 100mm. The bottom of pan is not flat.

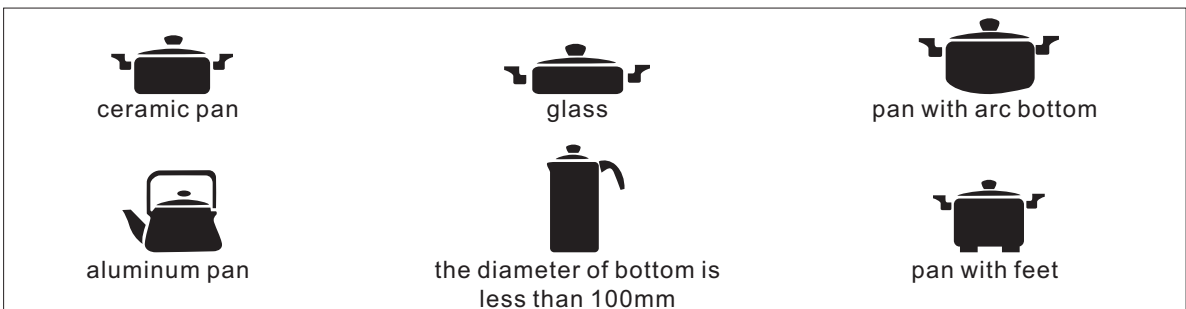

Use Instruction

Operation menu introduction

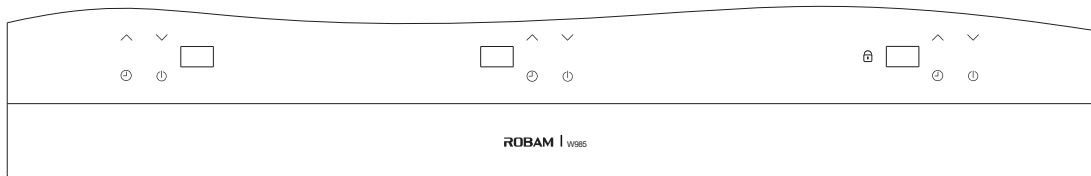

1. Power key “ A. Connected to the power, press the key “ B. In any working state, press the key “ When the appliance is in standby situation, press the key “2. “ In any working situation, when press this key more than 2 mintues, the appliance will start the lock function ,If customer want to cancel this function, please press this key more than 3 minutes again.

3. “ A. In any work state, press the key “ B. when the function of “Performance

1. Constant temperature control separated by 8 level, power rate as the following list, P1,P2 for intermittent heating.

Program	P1	P2	P3	P4	P5	P6	P7	P8
Electromagnetic heating power	400W	700W	1100W	1300W	1500W	1700W	1900W	2100W
Ceramic heating power	400W	500W	600W	700W	800W	900W	1000W	1100W





2. Have timing shutdown function: In working condition, you can set the timing shutdown function, the timing time is up to 99 minutes (can be set cycle).

Application









1. Turn on the power, the switch indicator light flashes 1 time/sec. If without any key operation, the switch indicator light will not shine.

2. Function activate







1) Press the key “” under the energized initial state, the buzzer makes a short sound and comes into standby, the digital tube statically displays “——”. Without any key operation, it will come back to the energized initial state.





2) Press the key “” or “” under the state of statically displaying “——”, the multifunction hob comes into the heating working condition. At this point the product is heating in the power of P4, then you can press the key “” or “” to increase or decrease the power.

Introduction of the function

1. In the condition of displaying “——”, press the key “” or “” once, the gas hob comes into the “heating” working condition, the digital tube displays “P4”, control the fire from P1 to P8 through the key “” or “”; in the working process, control the fire through the key “” or “” until the maximum or minimum firepower stall also pressing the key “” or “” can increase or decrease the power.





2. Timing shutdown function:

● When the product is in the “heating” working condition, press the key “” once, the digital tube displays the number “00”, press the key “” or “” to set time, after finish setting time, press the key “” again to make sure the time. If do not press “” to confirm, the digital tube will shine the time 3 times and set the time; at this point, the digital tube displays the left time of countdown (if the timing time need to be adjusted and the digital tube displays the present timing, press the key “” or “”); after finishing of countdown, alarms once and comes into the energized initial state;

● During the setting process, if you need to adjust or check the power, press the key “” or “”, the digital tube displays the present state and press the key “” or “” to adjust the power, it will come back to the present setting time 3 seconds after finish adjusting.

● Cancel the timing function: press the key “” three times, it will display the present power.

Child Lock Function

In heating condition, press the key “” 2 seconds, the buzzer makes a sound, the indicator light “” turns on. The machine locked in current state, only press “” is useful and other keys are invalid. If you want to unlock the child lock, press the key “” 3 seconds.

Turn off

After finish using, press the button “”, the multifunction hob will stop heating, after minute running of the fan, it automatically stop running. If the multifunction hob is using too long time without any modification, it will automatically turn off in 1hour (except the timing function).

Electrical Schematic Diagram

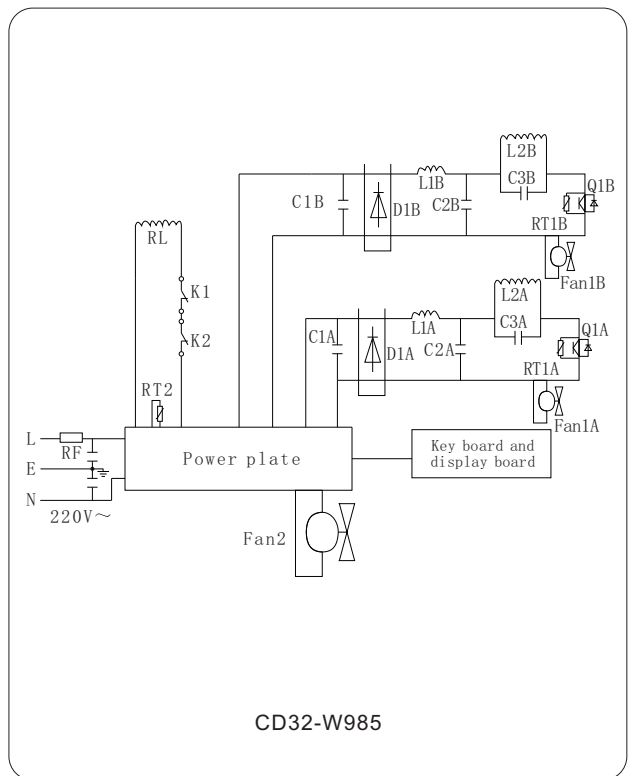
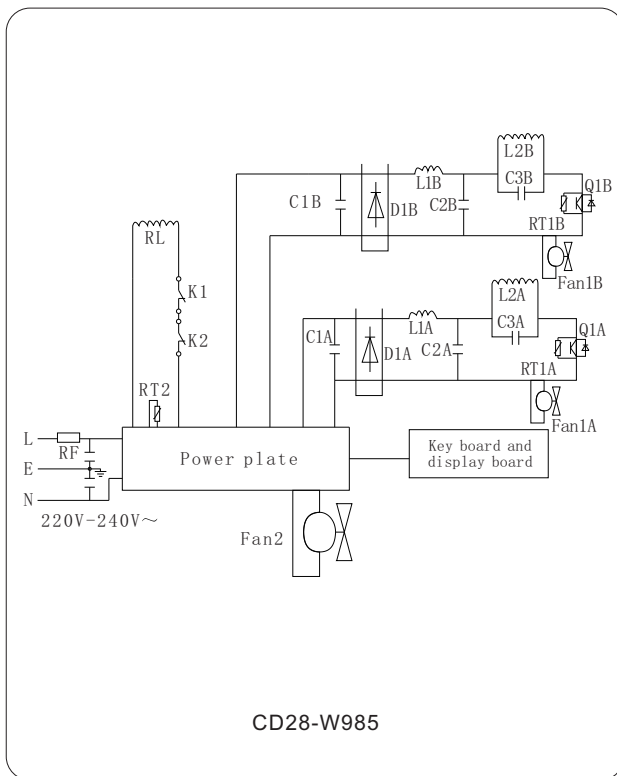

General Troubleshooting

No.	Common Faults		Problem Investigation
1	When Plug in the power plug, do not hear the "ding" sound, and the light does not turn on when press the switch.		①Is the plug tight ②Whether blackout ③Whether the switch, socket, fuse and power supply are intact
2	The indicator light lights, but it does not heat.		①Is the pot appropriate ②Whether in the reservation state ③Other reasons, please send to the authorized repair outlets
3	Stopping heating during the use		①Is the surrounding temperature too high ②Are the intake port, exhaust port blocked ③Whether the setting time has come regularly ④Sometimes the protection device works, wait a few minutes and then turn on the power and use ⑤Whether without any operation in 2 hours during the working process
4	During the (fixed temperature) using the temperature cannot be controlled		①The bottom of the pot is not flat, or the center is sunk ②The indicator light for setting temperature function is on or not..
5	The code of faults	E0、E5、E6、E7、Ed	Send to the authorized repair outlets ※If the fault is caused by dry, please remove the cookware and the panel can resume work after cooling. ※If the internal connection is unsuccessful.
		E1	Straighten the position of the pan or replace the applicable cookware, it will resume work.
		E2	Waite for a moment, temperature returns to normal, it will return to work.
		E3、E4	When the power supply voltage is normal, it can automatically resume operation.
6	Sweltering Tips	H	Panel temperature of the electric auxiliary oven is too high, do not touch the panel heating zone, caution hot.

⚠The power cord is 250V ~ 16A (for French plug) or 250V ~ 13A (for UK plug), if the plug is damaged, in order to avoid a hazard, it must be our company or our company' s maintenance department or similarly qualified persons to replace.

⚠These phenomena still cannot be excluded or not to restore the faults, please contact our authorized service point or dealer, strictly prohibit non-professionals disassemble the machine.

Installation Instruction

- 1.The table top of kitchen cabinet should be keep horizontal and clean. Make a aperture dimension on the table top of kitchen cabinet before installation. It need to clean the saw dust before installation ,otherwise it will interface the component of multifunction hob operation . Make sure whole kitchen cabinet stable after making a aperture dimension.
- 2.Keep distance no less than100mm from the air-taking hole to wall and keep space no less than 1000 mm in horizontal , please refer to instruction when install the hood .
- 3.Make a aperture dimension on the kitchen cabinet which can comply with requirement of ventilation and connect with air flow. (recommend size: width200mm height 200mm)
- 4.Make a aperture dimension on the table top according to the attached templet and make sure the four vertical smooth after make a dimension. keep distance no less than 100mm from the bottom of induction to cabinet.
- 5.It should be sealed to keep heat-resisting and swelled if making a aperture dimension on the wooden top
- 6.The kitchen cabinet material should bear 90 degree temperature
- 7.It needs to keep distance no less than 40mm from side wall to aperture hole
- We are not recommend you to put induction cooker in the middle of two wall, if that happened , please make sure leave 200mm distance from one of the wall to the aperture hole.
- 8.Make sure from the top of oven to the top of table reach to 70mm if want to install the oven
- 9.Make sure the thickness of table top no less than 20mm if wan to install the drawer
- 10.Make sure to make a 80mm cutting from two side' s board top to table top if the distance from two sides boards less than 758mm.

Installation schematic diagram

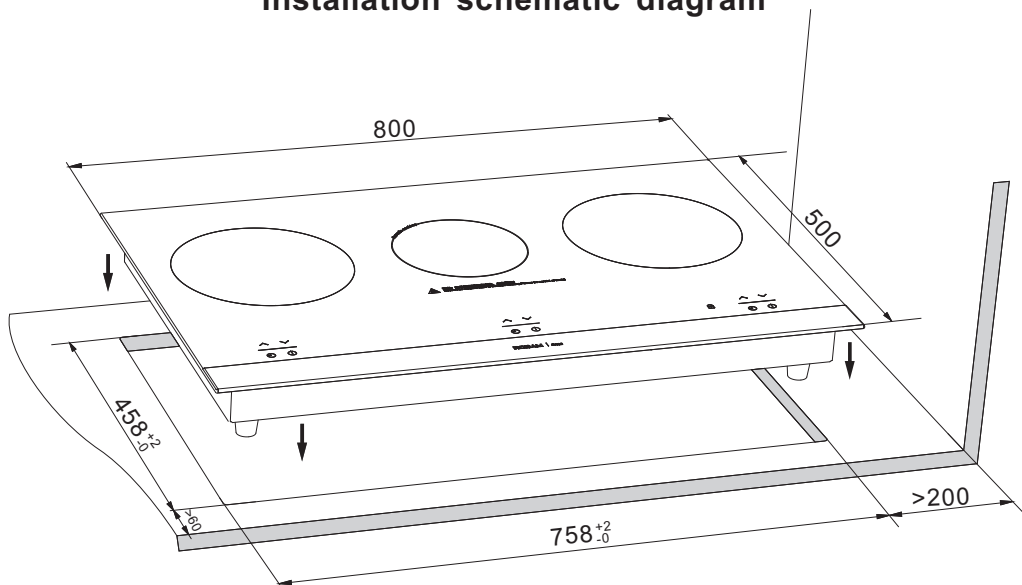

Cleaning and Maintenance

- Please cut off the wire before clean the multifunction hob, and the clean should be done after panel cooling.
- Don't pull down the plug directly under working state. The multifunction hob should be turned off firstly, then pull down the plug after fan stop working. It's helpful to prolong the life of product.

The method of clean the multifunction hobs

Body of product and control panel:

If the panel is dirty, please clean it by wet wiper, if the oil is hard to clean, please clean it by neutral cleanser firstly, and then clean it by soft wiper.

Panel:

If the panel is dirty, please clean it by wet wiper, if the oil is hard to clean, please clean it by neutral cleanser firstly, and then clean it by soft wiper.

Inlet and our let row surface:

Clean the dust by cotton stick. if there is some oil, users can clean it by brush with little neutral cleanser.

Remarks

1. Don't clean the machine body, inlet row and outlet row by organic solution, like oil or benzene. Please clean the machine body, inlet and outlet row by soft brush or cleaner regularly, if the dust is too much in the inlet row, it may shorten the life of multifunction hob.
2. Push cut off the wire every time after using the multifunction hob, wait some moments until the panel is cooling. Then clean the multifunction hob in time. If the smudginess is heated by the bottom of pan again and again, it will be hard to clean and make panel change color.
3. Don't allow to clean this product by steam cleansers.
4. If the surface appear crack, please turn off the multifunction hob and stock working immediately. It may cause electric shock.

Accessories

1. One instruction book
2. One carton board for explanation the dimensions of cut out area

Statement

If there is anything improvement on the technology, we will make it up in the new manual without special notice. The modification of appearance or color must be confirmed on base of actual object

ROBAM